

Article number: 203160M16150B1TK
 Description: E+G levelling foot
 GN 31-60-M16-150-B1-TK
 Note: TK With nut, Wrench flat at the bottom

Measures

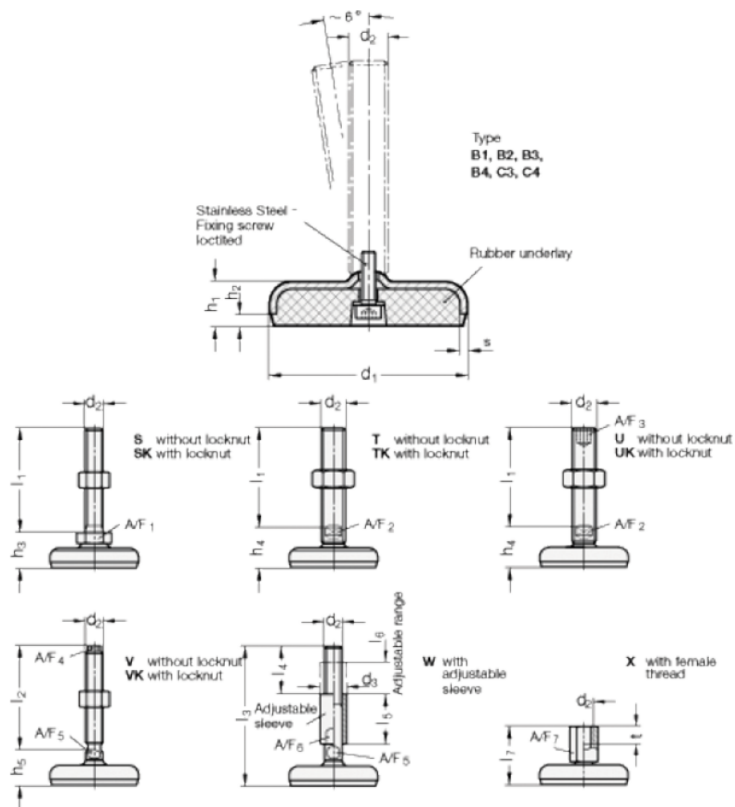

A/F2	= 12
d1	= 60
d2	= 16
h1	= 16
h2	= 4
h4 +4.0/0	= 30
l2	= 150
s	= 3